

SHARP

Multifunction Copiers & Printers

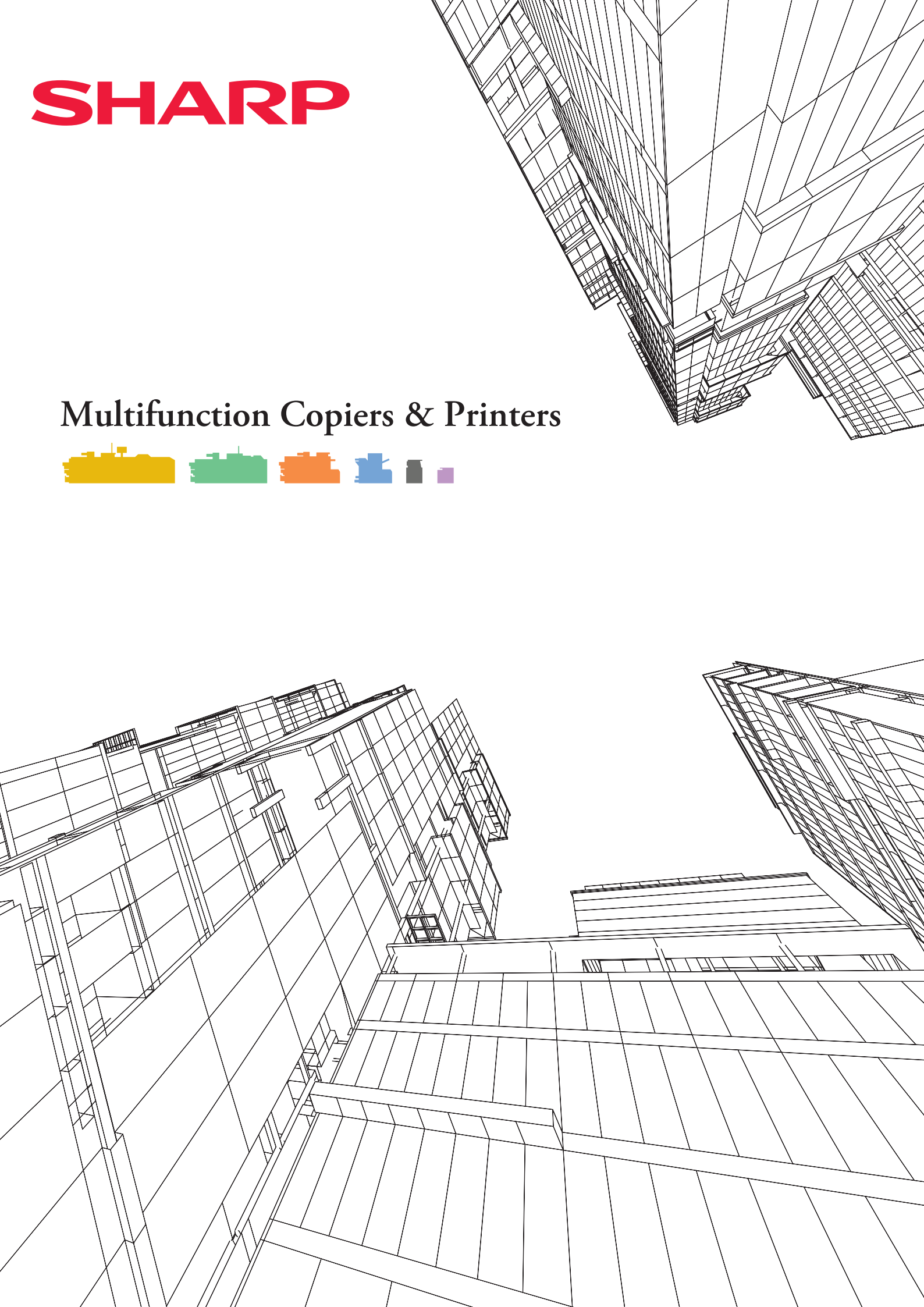

Work smarter with Sharp



SMART

Leveraging the latest technology can help you get everyday tasks done with ease and efficiency—that's the key to business success.

SEC

Information is one of our most valuable assets and needs to be safeguarded—security—that's the key to business success.

Global production reaches 21.1-million mark

Sharp has been producing innovative, high-quality document systems for over 50 years. Anticipating the diverse needs of our customers, we have continued to expand and refine our line-up of colour and B/W multifunction copiers and printers (MFPs). We offer the ideal document solution for any type of business, from the small home office to the large corporate setting. Sharp has earned a reputation around the world for helping people work better. It comes down to our innovative technologies, such as smart scanning, multi-layered security, and connectivity with mobile devices and cloud services.

Since the debut of our first copier, global production of our document systems has grown steadily. At the end of 2023, cumulative production surpassed 21.1 million units—ongoing proof of Sharp's success at offering reliable, high-performance document systems.

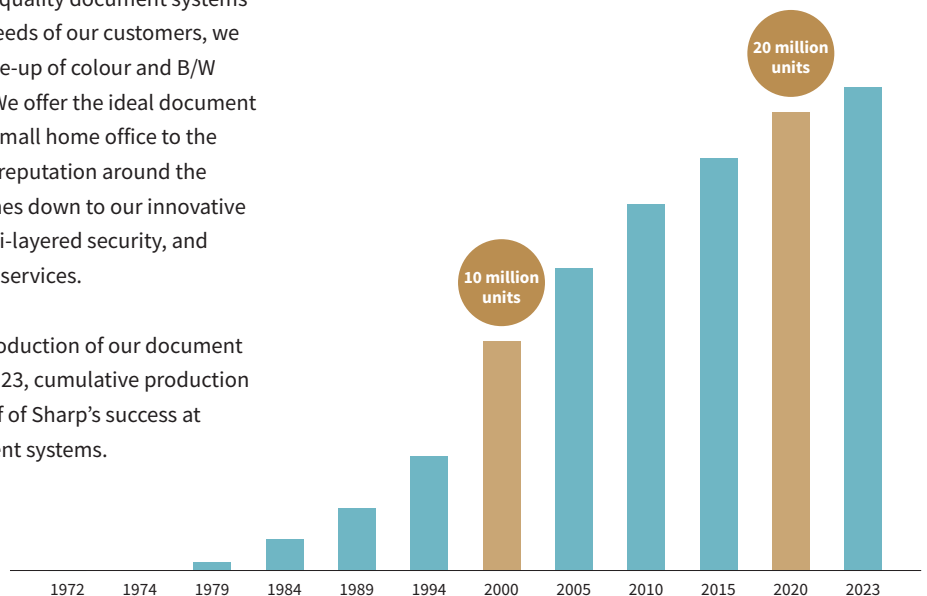

—whatever your business



VALUE

Business's greatest assets are guarded with the utmost care to propelling business.

CONNECTED

Interacting with others to get the job done regardless of time or space—that's the key to maximum value.

Contributing to the SDGs through business

In 1973, Sharp put into writing its business philosophy, which says the company will “contribute to the culture, benefits and welfare of people throughout the world” and that “our future prosperity is directly linked to the prosperity of our customers, dealers and shareholders.” These and other vows of the business philosophy share the aims of the Sustainable Development Goals (SDGs), which the UN enacted in 2015.

Under its business philosophy, Sharp carries out ESG management with a two-pronged approach: creating solutions to social problems through business and technological innovation, and reducing social and environmental impact through sustainable business activities. This approach will help achieve the SDGs and thereby contribute to a sustainable and better world where no one on Earth is left behind.

Learn more on <https://global.sharp/corporate/eco/sdgs/>

Providing smarter, more secure office solutions

The MFP was once a machine used only for managing paper-based information. But as working styles have evolved, the MFP has transformed into a comprehensive business tool that supports a range of tasks involving cloud-based data. Seamlessly boosting efficiency for workers in the office and beyond, Sharp MFPs and other office hardware have become indispensable to countless organisations. We aim to contribute to society by enhancing workspace environments through total solutions that improve the way people get their essential jobs done.

SMART

STREAMLINE DAILY OFFICE TASKS

When you're on the go and away from your usual desk, there are only so many paper documents you can keep on hand. To solve this problem, use an MFP to scan paper-based documents into digitised form. That way, they're easy to share with others working remotely. The MFP also lets you use text from paper documents as digital data. Now's the time to improve efficiency by embracing new ways of working.

Easy Scanning

Tap on the LCD touchscreen's Auto Set button to have the MFP perform a host of actions automatically. It can skip blank pages in a multi-page document or reorient pages mixed in upside down. The MFP also uses AI and image-processing technology to automatically determine the optimal resolution, gradation, and compression rate for your scan jobs.

Multicrop / Image Crop

Multiple receipts, photos, and other items can be scanned all at once, with each one saved as a separate file. This helps you streamline the filing of receipts and bills. The MFP can also crop photos from documents such as magazine pages and save them as individual files.



Card Shot (Multi)

Scan up to four ID or credit cards at once, turn them over, and scan the reverse sides. For each card, a separate file is created that includes the front and reverse sides.

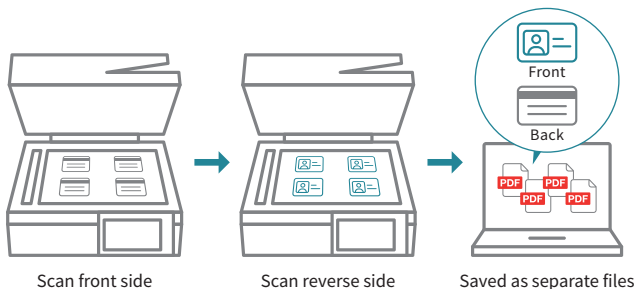

Business Card Feeder

A dedicated feeder on the DSPF/RSPF automatically feeds in and scans batches of business cards.

OCR

OCR (optical character recognition) capability on the MFP lets you convert a scanned document into a searchable PDF file or into an editable Office Open XML (pptx, xlsx, docx) file.

Business Card Management

The MFP reads the contact details on a business card via OCR and then exports these to your chosen contact management system.

USB Direct Scan

You can scan documents directly to a USB drive inserted into the MFP.

USB Direct Print*

Insert a USB drive into the MFP and a command screen will automatically pop up on the LCD. Right away you can print files from the USB drive, which are displayed as thumbnails.

*Direct printing of PDF files requires PostScript compatibility. Direct printing of Microsoft Office files requires Direct Print compatibility. Contact a Sharp customer representative to see if these functions are available on your MFP or if you need additional equipment.

Network Print

Network printing allows you to print documents from anywhere, simply by connecting to the office network via the internet. This comes in handy when you need to print from a remote location.

Office Direct Print*

Print common Microsoft Office files without using a PC. With the MFP, you can print a Word, Excel, or PowerPoint file directly from a mobile device, cloud service, USB drive, or file server.

*The actual printout may look different from what is displayed on the computer screen. This function is enabled via Qualcomm® DirectOffice™ technology.

ID Card Copy

The MFP lets you easily copy both sides of an ID card or credit card onto a single page.

Eco Packaging

Sharp has reduced plastic waste by using recyclable corrugated cardboard instead of polystyrene foam for the MFP's packaging.



EVEN MORE FLEXIBILITY

Work styles are changing, and offices are going paper-less. But businesses still need paper documents. And companies often need to produce flyers, direct mail, and business proposals in-house. With a Sharp MFP, creating professional-looking documents is a breeze. Now's the time to make a Sharp MFP a reliable partner in your office.

Saddle Stitch Finisher

This unit automates time-consuming tasks such as stapling, saddle-stitch binding, hole punching, and folding. It can also trim the edges of saddle-stitched documents to a beautifully consistent finish. You get seamless output—from printing to finishing—of leaflets, brochures, business proposals, and office meeting materials.

Note: Stapling requires a separate stapler, and hole punching and trim functions each require a separate module option.

Stapling



Rear corner



Front corner



2-point side

Punching



2-hole punching



3-hole punching



4-hole punching



4-hole wide punching

Trimming

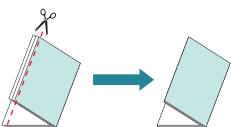

Saddle Stitching

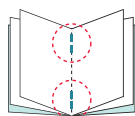

Saddle stitching

Folding Unit

This unit performs various types of automated folding*, such as Z-folds and C-folds, so you can efficiently produce direct mail and other items.

*Available fold types vary depending on the MFP model. Please refer to the leaflet for your chosen model. For certain types of folding, the MFP model will require a separate finisher option.



Z-fold



C-fold

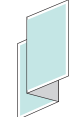

Accordion fold

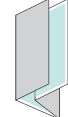

Double fold



Half-fold

Stapleless Stapler / Manual Stapler

Besides the conventional automated stapling function, the finisher offers two other ways to bind multi-page documents. You can either use the manual stapler to staple documents or the staple-free stapler to crimp the corners of pages together.

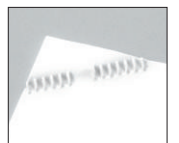

Staple-free stapling

Continuous Run

Thanks to an intermediate toner hopper, there's no need to stop the MFP during large-volume copy/print jobs when the toner cartridge needs changing. The MFP can use toner from the toner hopper to continue printing while the empty toner cartridge is replaced with a new one.

SECURE

SEAMLESS SECURITY

With advancements in information technology come threats such as computer viruses, information leaks, and unauthorised access. Dealing with these wide-ranging threats is one of the most pressing issues for business today—which is why MFPs should be treated the same as other IT equipment. Sharp MFPs reduce all sorts of security risks by, for example, blocking unauthorised access and preventing information leaks from printouts or storage media. Now's the time to build a safer and more secure business environment with a Sharp MFP.

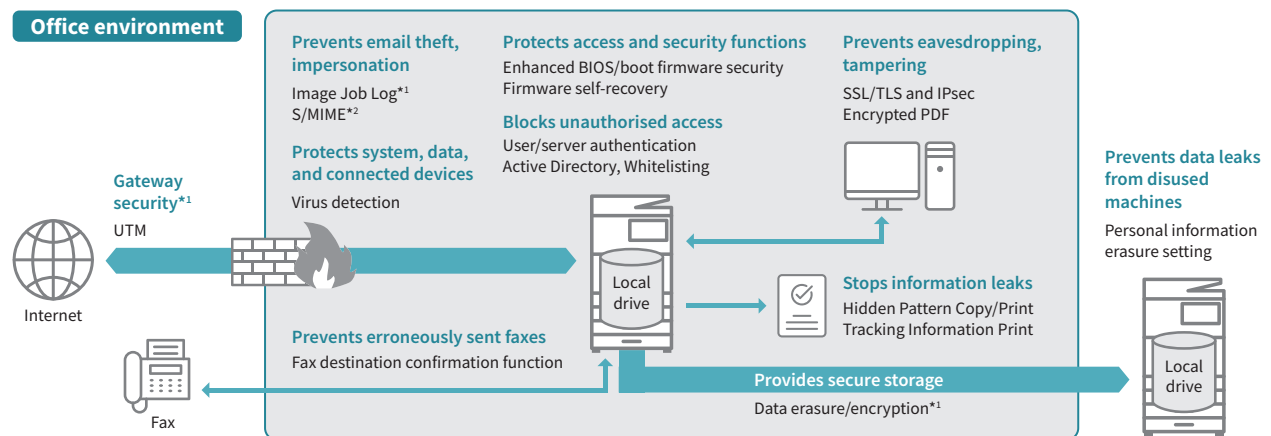

*1: Contact a Sharp customer representative for details on activating these functions. *2: Only when emailing scanned data.

BIOS/Boot Firmware Security

When booting up, the MFP checks for any anomalies in the BIOS/boot firmware. If it finds a problem, it aborts the startup. If there are other firmware-related issues, the MFP will attempt recovery to protect the system.

Virus Detection

Using the Bitdefender scan engine, the MFP defends against virus attacks on itself and connected devices. It scans for viruses and prevents the MFP from transmitting them to other devices like laptops and PCs.

Remote Firmware Updates

The MFP's firmware can be remotely updated—without the need for service operation—via a firmware update service, so you're always using the latest system for your MFP.

AD Group Policy Device Management

Group Policy enables centralised management of Windows PC settings within an Active Directory (AD) domain. System administrators can use it to simultaneously configure printer, proxy, and security settings for users and PCs.

Mandatory Access Control

This function protects the MFP from fraudulent programs trying to access the file system and obtain information.

Image Job Log*

This function creates and externally stores an image file (PDF) and a log file (XML) for each job. This helps identify unauthorised use of the MFP.

*Contact a Sharp customer representative for details on activating this function.





Server Authentication

The MFP supports external server authentication functions such as LDAP and Active Directory. With centralised management of multiple user credentials, system administrators can track usage of multiple MFPs.

S/MIME*

The MFP supports email encryption and digital signatures. Sending emails in encrypted format keeps data from leaking. It also prevents someone from masquerading as the sender or altering the content of an email.

*Only when emailing scanned data.

Data Encryption / Automatic Erasure*

Job data is encrypted before being saved to the MFP's internal storage. Once the data is output or sent, it is automatically erased.

*Contact a Sharp customer representative for details on activating this function.

SSL/TLS

SSL/TLS certificates encrypt transmitted data to prevent leakage and tampering, while ensuring that data is transmitted privately.

Trusted Platform Module

TPM is an industry-standard chip that uses cryptoprocessor technology to protect hardware such as MFP hard drives. It generates a cryptographic key that can't be accessed by software, with a matching key encoded during boot-up. If the two keys don't match, access to the device is denied. TPM is vital for shielding your network from data storage attacks.

Document Control

This function prevents unauthorised use of confidential documents* by embedding copy-prevention data in them.

*May not work with certain types of paper, documents (such as those with a lot of photos), or MFP settings.

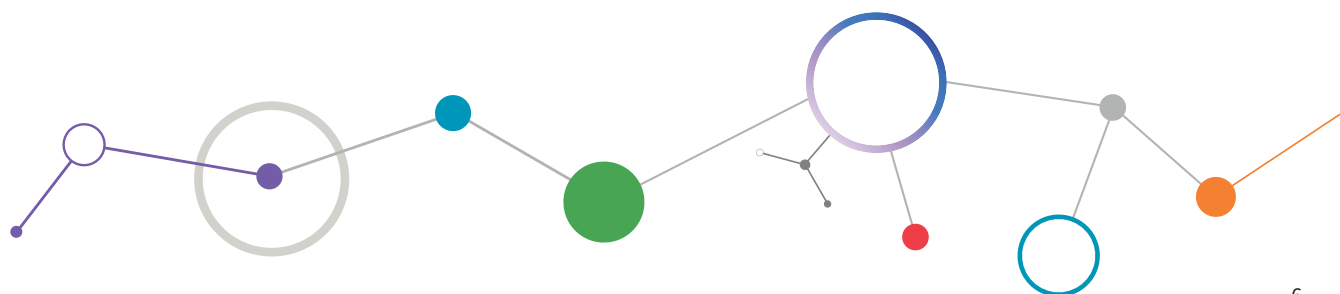

CONNECTED



LINK TO CLOUD SERVICES

Make sure you and your co-workers can access each other's digital and hard-copy information, so you can maximise teamwork and creative collaboration. Use the MFP to swiftly scan documents and upload them to cloud services for sharing with your team. View, edit, and print documents regardless of whether you're inside or outside the office. Now's the time for smart information sharing, with a Sharp MFP.

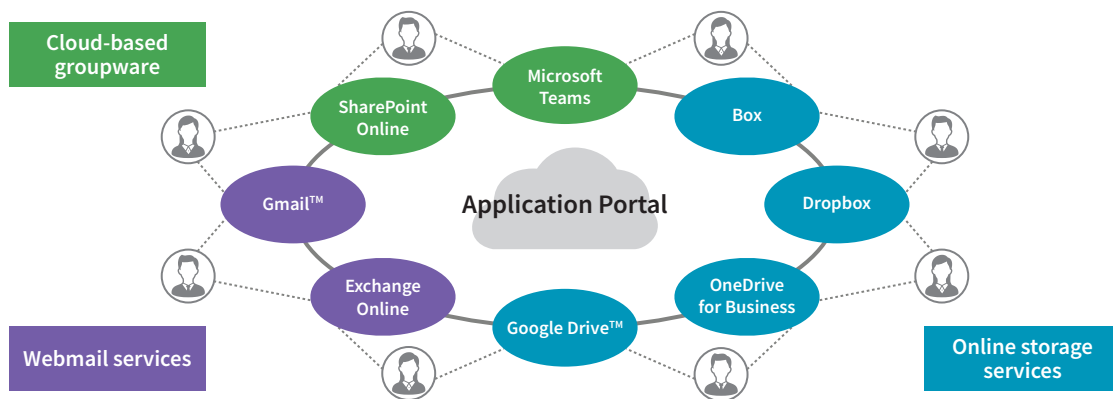

Cloud Storage Connection

Directly from the MFP's control panel, you can connect with cloud services and upload scanned data to them or print directly from them. Supported services*¹ include Google Drive™, OneDrive for Business, SharePoint Online, Box, and Dropbox. Apps for these services can be downloaded and installed on your MFP via Sharp's Application Portal*². App updates are easily recognisable, so you'll always be up to date with the latest services. Once you log in to the MFP, its single sign-on feature allows you to quickly access multiple software services without having to sign in to each one separately.

*¹ Some services are not available on some models. Contact a Sharp customer representative for details.

*² Contact a Sharp customer representative for details.

Teams Connector

This feature streamlines workflow and enhances collaboration in your team. You can easily print from Teams channels and folders and scan documents to them too.

Cloud Mail Connection

Scanned data can be conveniently sent via your regular Gmail™ or Microsoft Exchange/Online account.

LINK WITH MOBILE DEVICES

Companies are supporting diversified work styles for their employees. Mobile devices like tablets and smartphones are now indispensable to doing business. Swiftly linking MFPs with mobile devices streamlines complex, time-consuming workflows and gives easy access to data on devices. Now's the time to streamline tasks and create further value.



Mobile Print

Sharp MFPs and printers support popular mobile printing services* such as AirPrint and Sharp Print Service Plugin.

*Some services are not available on some models. Contact a Sharp customer representative for details.

Sharpdesk Mobile*

Mobile devices installed with this print/scan app can connect directly to the MFP for printing or downloading scanned data. To connect, simply hold your mobile device over the MFP's NFC tag or scan the MFP's QR Code.

*Availability varies by country/region. For details, see the Sharpdesk Mobile support website: https://global.sharp/products/copier/docu_solutions/mobile/sharpdesk_mobile/ Some functions may require optional equipment, depending on the MFP model. Please refer to the relevant product brochure.

SMOOTHER ADMIN WORKFLOW

Sharp MFPs make life easier for system administrators by supporting a range of management tasks. The seamless functionality of our MFPs brings a new level of control and convenience. Along with connection to mobile devices and external cloud services, Sharp MFPs boast an array of smart functions to boost your workflow.

Print Release*

This lets you send documents to the main MFP, which acts as a server and stores them for printing out from any other compatible MFP on the network. This function comes in handy when the main MFP is in use or under maintenance, letting you finish your job with minimal waiting.

*Contact a Sharp customer representative for details on the recommended maximum number of connectable MFPs.

Sharp OSA (Open Systems Architecture)

Linking MFP functions with third-party applications automates entire tasks, covering everything from input and processing to output, and boosting work efficiency.

Remote Operation

Using the Sharp Remote Front Panel feature, helpdesk and admin staff can access and control the Sharp MFP from a remote PC workstation.

eSF (Embedded Solutions Framework)

eSF allows users to accomplish a variety of tasks from the MFP/printer through an intuitive Java-based platform. It boosts user productivity by streamlining or eliminating paper-intensive work processes.

Basic Specifications / Notable Functions

XX PPM	Maximum engine speed* ¹ (ppm: pages per minute)	XX sheets	Maximum paper capacity (80 g/m ²)	XX	Maximum paper size	XX-XX gsm	Paper weight	XX	Type and size of LCD control panel
Motion Sensor	Detects approaching users and wakes the MFP from sleep mode	XX GB	Standard-equipped memory	XX GB	Standard-equipped SSD/HDD/eMMC	DSPF XX sheets	Duplex single pass feeder; scans both pages of two-sided documents in one pass in batches of up to XX sheets	RSPF XX sheets	Reversing single pass feeder; automatically feeds in one- or two-sided originals in batches of up to XX sheets
XX OPM	Maximum scan speed* ² (opm: originals per minute)	Print XX dpi	Print resolution	Adobe PS	Adobe PostScript 3	PS	PostScript 3 emulation	Wireless LAN	Wireless LAN capability* ³
NFC	Allows easy connection with mobile devices								

*¹ A3 machines: A4 (8 1/2" x 11"), long-edge feeding. A4 machines: A4 (8 1/2" x 11"), short-edge feeding.
² When feeding A4 (8 1/2" x 11") sheets. *³ Availability varies by country/region.



SHARP COLOUR MFPs

BP-70C65/70C45



Copy	Print	Scan	Fax
65/45 PPM	6300 sheets	SRA3/A3W	55-300 gsm
Motion Sensor	5 GB	256 GB SSD	DSPF 300 sheets
Adobe PS	WiFi *1	NFC	280 OPM
			Print 1200 dpi



SMART

Easy Scanning	Multicrop / Image Crop	Card Shot (Multi)	Business Card Feeder
OCR	Business Card Management	USB Direct Scan	USB Direct Print
Network Print	Office Direct Print	ID Card Copy*2	Eco Packaging
Saddle Stitch Finisher	Folding Unit	Stapless Stapler / Manual Stapler	Continuous Run

Available on BP-70C65

SECURE

BIOS Firmware Security	Virus Detection	Remote Firmware Updates	AD Group Policy Device Management
Mandatory Access Control	Image Job Log	Server Authentication	S/MIME
Data Encryption / Automatic Erasure	SSL/TLS	Trusted Platform Module	Document Control

CONNECTED

Cloud Storage Connection*1	Teams Connector*1	Cloud Mail Connection	Mobile Print
Sharpdesk Mobile	Print Release	Remote Operation	Sharp OSA*1

■ Functions available ■ Functions available as option □ Functions not available
 For explanations of the features, see pages 3 to 8. For details, see the product brochure.

*1 In some countries/regions, certain functions are not standard.
 *2 Similar results can be obtained using another standard built-in function.

SYSTEM CONFIGURATION

BP-FN13** Finisher (1,250)

BP-FN14** Saddle Stitch Finisher (1,250)

BP-FN15** Finisher (3,250)

BP-FN16** Saddle Stitch Finisher (3,250)

MX-TR20 N Job Separator Tray

BP-TU10**** Exit Tray Cabinet

BP-FN11/FN12**** Finisher (500)

BP-RB10 Paper Pass Unit

BP-FD10 Folding Unit (200)

BP-DE12 Stand with 550-sheet Paper Drawer

BP-DE13 Stand with 2 x 550-sheet Paper Drawer

BP-DE14 Stand with 3 x 550-sheet Paper Drawer

BP-DE15 Stand with 550 + 2,100-sheet Paper Drawer

BP-UT10 Utility Table

BP-TR12 Exit Tray Unit

MX-LT10 Long Paper Feeding Tray

BP-LC10** Large Capacity Tray (A4) (3,000)

MX-PN14B/C/D Punch Module (for BP-FN11/FN12)

MX-PN15B/C/D Punch Module (for BP-FN13/FN14)

MX-PN16B/C/D Punch Module (for BP-FN15/FN16)

MX-PF10/PF10L Barcode Font Kit

BP-FX11 Fax Expansion Kit

MX-FWX1/FWX1L Internet Fax Expansion Kit

BP-DD10 Double Feed Detection Kit

MX-AMX1/AMX1L Application Integration Module

BP-AM10/AM10L*** Application Communication Module

BP-AM11/AM11L*** External Account Module

BP-EB10**** Wireless Connection Adaptor

BP-SD10 High Capacity SSD

BP-FR12U/FR12UL Data Security Kit

BP-VD10/VD10L Virus Detection Kit

** Minimum required equipment.
 *** Requires BP-DE12/DE13/DE14/DE15.
 **** In some countries/regions, certain features/functions are standard-equipped (not optional) on the base unit.
 ***** BP-FN12 for BP-70C65 and BP-FN11 for the other models.
 ***** 100 sheets when using the folding unit together with the BP-FN13/FN14/FN15/FN16.

Certain optional equipment may not be available in some areas.

BP-50C55/50C45
BP-50C36/50C31
BP-50C26
BP-50C31T/50C26T



Copy	Print	Scan	Fax
55/45/36/31/26 PPM	6300 sheets	SRA3/A3W	55-300 gsm
10.1" Motion Sensor	5 GB	128 GB SSD	RSPF 100 sheets
80 OPM	Print 1200 dpi	Adobe PS	NFC

PANTONE Digital Color

Works with Apple AirPrint OPTION

SMART

Easy Scanning	Multicrop / Image Crop	Card Shot (Multi)	Business Card Feeder
OCR	Business Card Management	USB Direct Scan	USB Direct Print
Network Print	Office Direct Print	ID Card Copy*	Eco Packaging
Saddle Stitch Finisher	Folding Unit	Stapless Stapler / Manual Stapler	Continuous Run <small>Available on BP-50C55</small>

SECURE

BIOS Firmware Security	Virus Detection	Remote Firmware Updates	AD Group Policy Device Management
Mandatory Access Control	Image Job Log	Server Authentication	S/MIME
Data Encryption / Automatic Erasure	SSL/TLS	Trusted Platform Module	Document Control

CONNECTED

Cloud Storage Connection	Teams Connector	Cloud Mail Connection	Mobile Print
Sharpdesk Mobile	Print Release	Remote Operation	Sharp OSA

■ Functions available ■ Functions available as option □ Functions not available
For explanations of the features, see pages 3 to 8. For details, see the product brochure.

* Similar results can be obtained using another standard built-in function.

SYSTEM CONFIGURATION

<p>BP-FN13** Finisher (1,250)</p> <p>BP-FN14** Saddle Stitch Finisher (1,250)</p> <p>BP-FN15** Finisher (3,250)</p> <p>BP-FN16** Saddle Stitch Finisher (3,250)</p>	<p>MX-TR20 N Job Separator Tray</p> <p>BP-FN11/FN12*** Finisher</p> <p>BP-RB10 Paper Pass Unit</p> <p>BP-FD10 Folding Unit</p>	<p>BP-TU10* Exit Tray Cabinet</p> <p>BP-UT10 Utility Table</p> <p>BP-TR12 Exit Tray Unit</p> <p>MX-LT10 Long Paper Feeding Tray</p> <p>BP-LC10** Large Capacity Tray (A4)</p>	<p>BP-DE12 Stand with 550-sheet Paper Drawer</p> <p>BP-DE13 Stand with 2 x 550-sheet Paper Drawer</p> <p>BP-DE14 Stand with 3 x 550-sheet Paper Drawer</p> <p>BP-DE15 Stand with 550 + 2,100-sheet Paper Drawer</p>	<p>MX-PN14B/C/D Punch Module (for BP-FN11/FN12)</p> <p>MX-PN15B/C/D Punch Module (for BP-FN13/FN14)</p> <p>MX-PN16B/C/D Punch Module (for BP-FN15/FN16)</p> <p>MX-PK13/PK13L PS3 Expansion Kit</p> <p>MX-PU10/PU10L Direct Print Expansion Kit</p> <p>MX-PF10/PF10L Barcode Font Kit</p> <p>BP-FX11 Fax Expansion Kit</p> <p>MX-FWX1/FWX1L Internet Fax Expansion Kit</p> <p>MX-AMX1/AMX1L Application Integration Module</p>	<p>BP-AM10/AM10L Application Communication Module</p> <p>BP-AM11/AM11L External Account Module</p> <p>BP-EB10 Wireless Connection Adaptor</p> <p>MX-EB19/EB19L Enhanced Compression Kit</p> <p>MX-EB20/EB20L OCR Expansion Kit</p> <p>BP-SD10 High Capacity SSD</p> <p>BP-FR12U/FR12UL Data Security Kit</p> <p>BP-VD10/VD10L Virus Detection Kit</p>
---	--	--	---	--	---

* Minimum required equipment. In some countries/regions, the BP-TU10 is standard-equipped (not optional) on the base unit.
** Requires BP-DE12/DE13/DE14/DE15.
*** BP-FN11 for the other models.
**** 100 sheets when using the folding unit together with the BP-FN13/FN14/FN15/FN16.

Certain optional equipment may not be available in some areas.

BP-30C25Z/30C25ZT



Copy	Print	Scan	Fax
25 PPM	1850 sheets	A3W	55-256 gsm
7.0"	Motion Sensor	5 GB	128 GB
RSPF 100 sheets	52 OPM	Print 600 dpi	Adobe PS
Wi-Fi	NFC		



SMART

Easy Scanning	Multicrop / Image Crop	Card Shot (Multi)	Business Card Feeder
OCR	Business Card Management	USB Direct Scan	USB Direct Print
Network Print	Office Direct Print	ID Card Copy*	Eco Packaging
Saddle Stitch Finisher	Folding Unit	Stapless Stapler / Manual Stapler	Continuous Run

SECURE

BIOS Firmware Security	Virus Detection	Remote Firmware Updates	AD Group Policy Device Management
Mandatory Access Control	Image Job Log	Server Authentication	S/MIME
Data Encryption / Automatic Erasure	SSL/TLS	Trusted Platform Module	Document Control

CONNECTED

Cloud Storage Connection	Teams Connector	Cloud Mail Connection	Mobile Print
Sharpdesk Mobile	Print Release	Remote Operation	Sharp OSA

Functions available
 Functions available as option
 Functions not available

For explanations of the features, see pages 3 to 8. For details, see the product brochure.

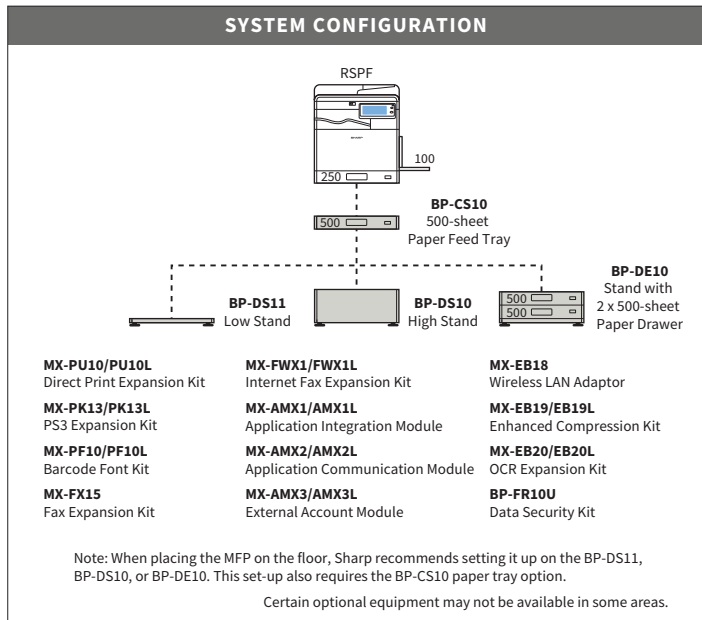

*Similar results can be obtained using another standard built-in function.



BP-22C25/22C20 BP-22C25T/22C20T



Copy	Print	Scan	Fax
25/20 PPM	1850 sheets	A3W	55-256 gsm
7.0"	Motion Sensor	2 GB	16 GB
RSPF 100 sheets	31 OPM	Print 600 dpi	PS
Wireless	NFC		



SMART

Easy Scanning	Multicrop / Image Crop	Card Shot (Multi)	Business Card Feeder
OCR	Business Card Management	USB Direct Scan	USB Direct Print
Network Print	Office Direct Print	ID Card Copy	Eco Packaging
Saddle Stitch Finisher	Folding Unit	Stapless Stapler / Manual Stapler	Continuous Run

SECURE

Boot Firmware Security	Virus Detection	Remote Firmware Updates	AD Group Policy Device Management
Mandatory Access Control	Image Job Log	Server Authentication	S/MIME
Data Encryption / Automatic Erasure	SSL/TLS	Trusted Platform Module	Document Control

CONNECTED

Cloud Storage Connection	Teams Connector	Cloud Mail Connection	Mobile Print
Sharpdesk Mobile	Print Release	Remote Operation	Sharp OSA

Functions available
 Functions available as option
 Functions not available

For explanations of the features, see pages 3 to 8. For details, see the product leaflet.

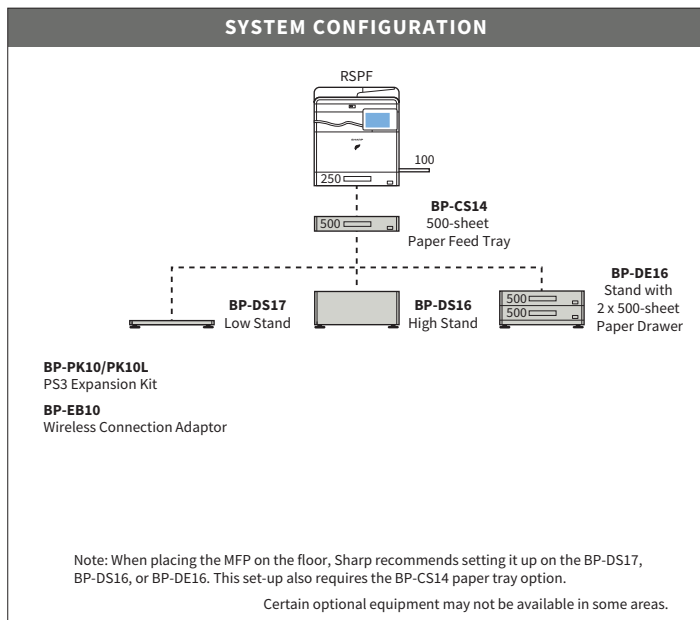

BP-C533WD



Copy	Print	Scan	Fax
33 PPM	2350 sheets	A4	55-220 gsm
7.0"	Motion Sensor	— BP-C533WD —	
5 GB	128 GB SSD	DSPF 100 sheets	130 OPM
RSPF 50 sheets	40 OPM	Print 1200 dpi	Adobe PS
WiFi	NFC		



SMART

Easy Scanning	Multicrop / Image Crop	Card Shot (Multi)	Business Card Feeder
OCR	Business Card Management	USB Direct Scan	USB Direct Print
Network Print	Office Direct Print	ID Card Copy	Eco Packaging
Saddle Stitch Finisher	Folding Unit	Stapless Stapler / Manual Stapler	Continuous Run

SECURE

BIOS Firmware Security	Virus Detection	Remote Firmware Updates	AD Group Policy Device Management
Mandatory Access Control	Image Job Log	Server Authentication	S/MIME
Data Encryption / Automatic Erasure	SSL/TLS	Trusted Platform Module	Document Control

CONNECTED

Cloud Storage Connection	Teams Connector	Cloud Mail Connection	Mobile Print
Sharpdesk Mobile	Print Release	Remote Operation	Sharp OSA

Functions available
 Functions available as option
 Functions not available

For explanations of the features, see pages 3 to 8. For details, see the product brochure.

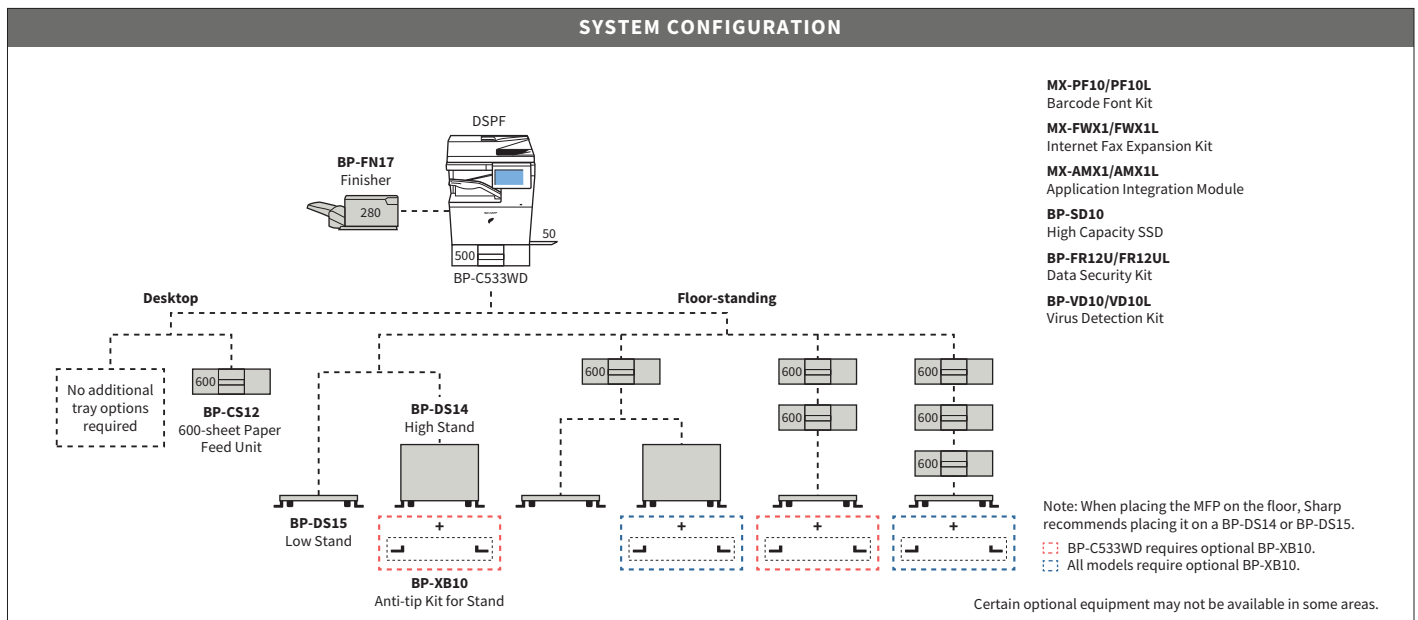



SHARP MONO MFPs

MX-M1206/M1056



Copy Print Scan Fax

120/105 PPM	13500 sheets	SRA3/A3W	52-300 gsm	15.4"
Motion Sensor	6 GB	1 TB HDD	DSPF 300 sheets	240 OPM
Adobe PS	Wi-Fi	NFC	Print 1200 dpi	



SMART

Easy Scanning	Multicrop / Image Crop	Card Shot (Multi)	Business Card Feeder
OCR	Business Card Management	USB Direct Scan	USB Direct Print
Network Print	Office Direct Print	ID Card Copy*	Eco Packaging
Saddle Stitch Finisher	Folding Unit	Stapless Stapler / Manual Stapler	Continuous Run

SECURE

BIOS Firmware Security	Virus Detection	Remote Firmware Updates	AD Group Policy Device Management
Mandatory Access Control	Image Job Log	Server Authentication	S/MIME
Data Encryption / Automatic Erasure	SSL/TLS	Trusted Platform Module	Document Control

CONNECTED

Cloud Storage Connection	Teams Connector	Cloud Mail Connection	Mobile Print
Sharpdesk Mobile	Print Release	Remote Operation	Sharp OSA

■ Functions available ■ Functions available as option □ Functions not available
For explanations of the features, see pages 3 to 8. For details, see the product brochure.

*Similar results can be obtained using another standard built-in function.

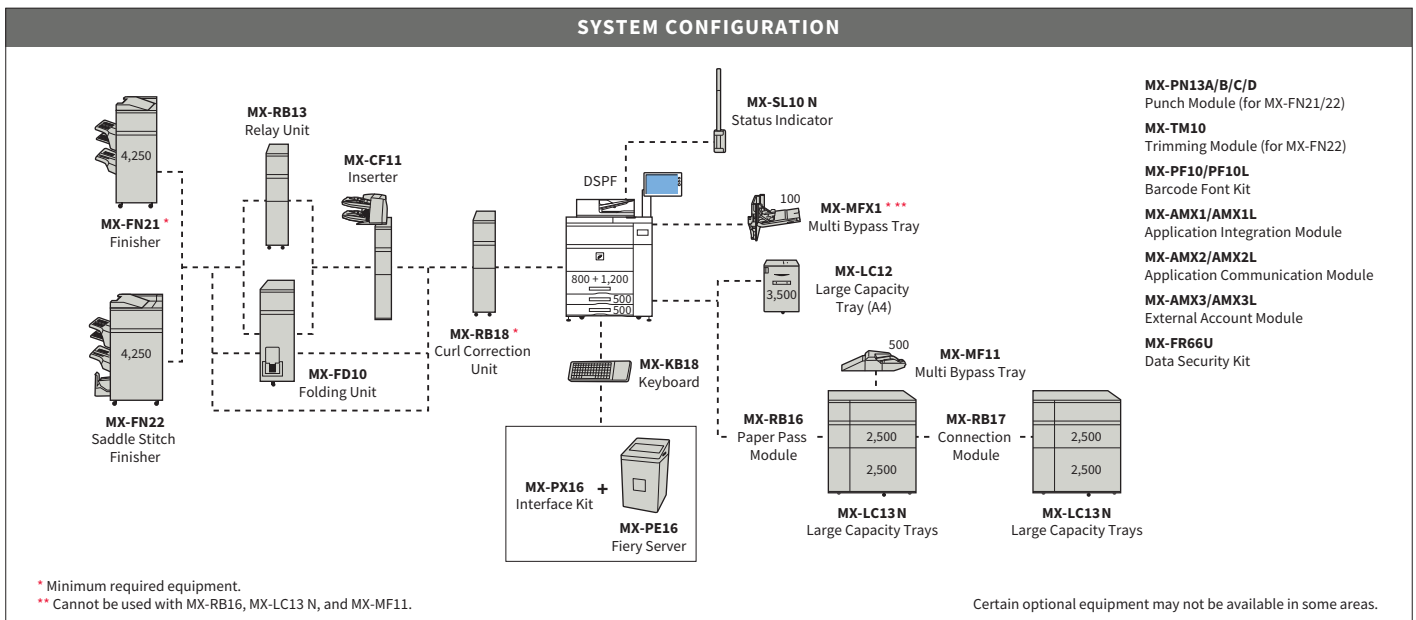

Enhanced Reliability

The MFP is built for durability and easy maintenance. It features smart built-in systems and options that help to minimise downtime and improve productivity.

Highly Rigid Main Frame A highly rigid support frame isolates and protects critical machine components in the MFP, ensuring increased durability and reliability. The unit can withstand heavy use in locations where rapid, high-volume output is demanded.

Air-feed System For smooth paper handling and travel, an air-feed system on the optional MX-LC13 N Large Capacity Trays minimises paper jams and the feeding of more than one sheet at a time.

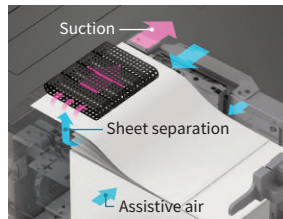

Multi-feed Detection System A precision-engineered Multi-Feed Detection System on the MFP employs ultrasonic technology to detect misfeeds in the DSPF and the paper feed section of the paper trays.

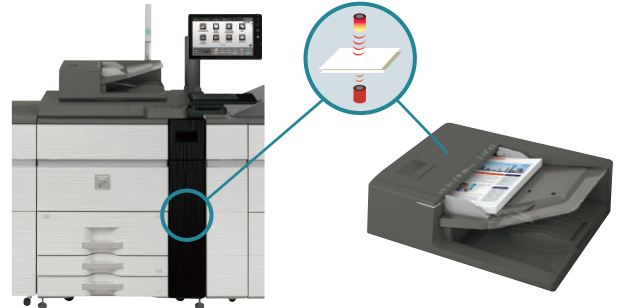

Professional-quality In-line Finishing Options

A range of finishing options work to automate time-consuming finishing tasks. Options are available to suit a variety of workplaces and applications.

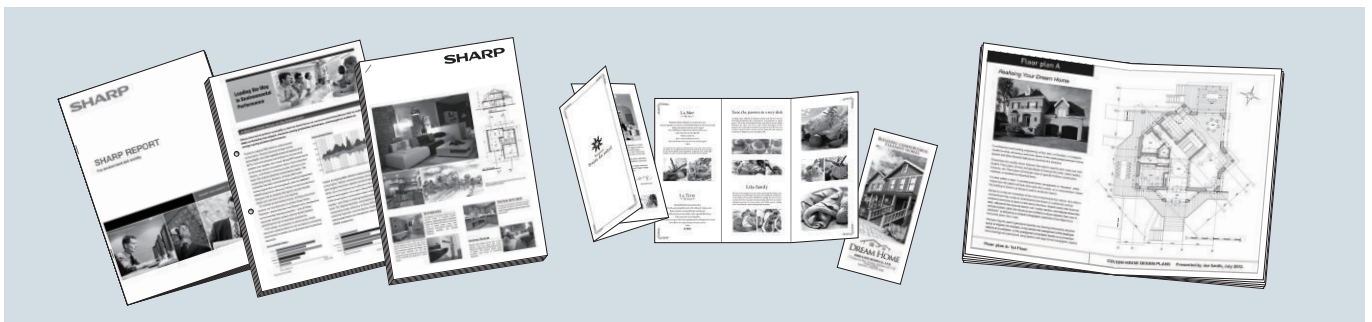

Stapling

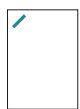

Rear corner

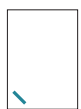

Front corner



2-point side

Punching



2-hole punching



3-hole punching



4-hole punching



4-hole wide punching

Saddle Stitching

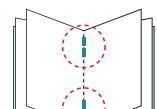

Saddle stitching

Trimming

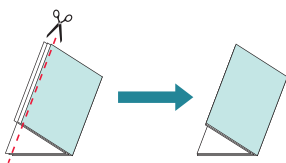

Folding

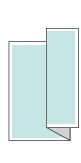

Z-fold

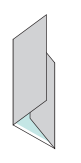

C-fold

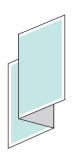

Accordion fold

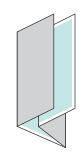

Double fold

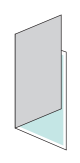

Half-fold

Insertion



Cover

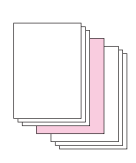

Inner page

Fiery® Server for Outstanding Quality and Efficiency

Paired with the an industry-leading Fiery external server, this MFP becomes a powerful integrated solution for managing professional in-plant and busy on-demand printing environments. This winning combination offers the following benefits, to name just a few:

- Easily manage jobs with Fiery Command WorkStation® fully integrated at the MFP's touchscreen for unmatched control and ease of use
- Deliver high-impact documents that maintain consistent results page after page
- Process large, complex jobs at speeds of 120/105 ppm that will exceed your expectations

BP-70M90/70M75



Copy	Print	Scan	Fax
90/75 PPM	6700 sheets	A3W	55-300 gsm
10.1"	Motion Sensor	5 GB	256 GB SSD
DSPF 300 sheets	280 OPM	Print 1200 dpi	Adobe PS
*1	NFC		



SMART

Easy Scanning	Multicrop / Image Crop	Card Shot (Multi)	Business Card Feeder
OCR	Business Card Management	USB Direct Scan	USB Direct Print
Network Print	Office Direct Print	ID Card Copy*2	Eco Packaging
Saddle Stitch Finisher	Folding Unit	Stapless Stapler / Manual Stapler	Continuous Run

SECURE

BIOS Firmware Security	Virus Detection	Remote Firmware Updates	AD Group Policy Device Management
Mandatory Access Control	Image Job Log	Server Authentication	S/MIME
Data Encryption / Automatic Erasure	SSL/TLS	Trusted Platform Module	Document Control

CONNECTED

Cloud Storage Connection*1	Teams Connector*1	Cloud Mail Connection	Mobile Print
Sharpdesk Mobile	Print Release	Remote Operation	Sharp OSA*1

Functions available
 Functions available as option
 Functions not available

*1 In some countries/regions, certain functions are not standard.
*2 Similar results can be obtained using another standard built-in function.

SYSTEM CONFIGURATION

MX-FN34 Finisher (3,250)

MX-FN35 Saddle Stitch Finisher (3,250)

MX-FN21 Finisher (4,250)

MX-FN22 Saddle Stitch Finisher (4,250)

MX-FD10 Folding Unit

MX-RB13 Relay Unit

MX-CF11 Inserter

MX-RB27 Curl Correction Unit

MX-TU15* Exit Tray Cabinet

MX-RB26 Paper Pass Unit

DSPF (1,250 + 850)

MX-TR21 Exit Tray Unit

MX-LT10 Long Paper Feeding Tray

BP-LC11 Large Capacity Tray (A4) (3,500)

MX-LC19 Large Capacity Tray (A3) (3,000)

MX-PN16B/C/D Punch Module (for MX-FN34/FN35)

MX-PN13A/B/C/D Punch Module (for MX-FN21/FN22)

MX-TM10 Trimming Module (for MX-FN22)

MX-PF10/PF10L Barcode Font Kit

BP-FX11 Fax Expansion Kit

MX-FWX1/FWX1L Internet Fax Expansion Kit

BP-DD10 Double Feed Detection Kit

MX-AMX1/AMX1L Application Integration Module

BP-AM10/AM10L** Application Communication Module

BP-AM11/AM11L** External Account Module

BP-EB10** Wireless Connection Adaptor

BP-SD10 High Capacity SSD

MX-FR12U/FR12UL Data Security Kit

BP-VD10/VD10L Virus Detection Kit

* Minimum required equipment
** In some countries/regions, certain features/functions are standard-equipped (not optional) on the base unit.

Certain optional equipment may not be available in some areas.

BP-70M65/70M55



Copy	Print	Scan	Fax
65/55 PPM	6300 sheets	A3W	55-300 gsm
Motion Sensor	5 GB	256 GB SSD	DSPF 300 sheets
Adobe PS	WiFi *1	NFC	280 OPM
			Print 1200 dpi



SMART

Easy Scanning	Multicrop / Image Crop	Card Shot (Multi)	Business Card Feeder
OCR	Business Card Management	USB Direct Scan	USB Direct Print
Network Print	Office Direct Print	ID Card Copy*2	Eco Packaging
Saddle Stitch Finisher	Folding Unit	Stapless Stapler / Manual Stapler	Continuous Run

SECURE

BIOS Firmware Security	Virus Detection	Remote Firmware Updates	AD Group Policy Device Management
Mandatory Access Control	Image Job Log	Server Authentication	S/MIME
Data Encryption / Automatic Erasure	SSL/TLS	Trusted Platform Module	Document Control

CONNECTED

Cloud Storage Connection*1	Teams Connector*1	Cloud Mail Connection	Mobile Print
Sharpdesk Mobile	Print Release	Remote Operation	Sharp OSA*1

■ Functions available ■ Functions available as option □ Functions not available
 For explanations of the features, see pages 3 to 8. For details, see the product brochure.

*1 In some countries/regions, certain functions are not standard.
 *2 Similar results can be obtained using another standard built-in function.

SYSTEM CONFIGURATION

BP-FN13** Finisher (1,250)

BP-FN14** Saddle Stitch Finisher (1,250)

BP-FN15** Finisher (3,250)

BP-FN16** Saddle Stitch Finisher (3,250)

BP-DE12 Stand with 550-sheet Paper Drawer

BP-DE13 Stand with 2 x 550-sheet Paper Drawer

BP-DE14 Stand with 3 x 550-sheet Paper Drawer

BP-DE15 Stand with 550 + 2,100-sheet Paper Drawer

BP-TU10**** Exit Tray Cabinet

BP-FN11/FN12**** Finisher

BP-RB10 Paper Pass Unit

BP-FD10 Folding Unit

BP-UT10 Utility Table

BP-TR12 Exit Tray Unit

MX-LT10 Long Paper Feeding Tray

BP-LC10** Large Capacity Tray (A4)

MX-PN14B/C/D Punch Module (for BP-FN11/FN12)

MX-PN15B/C/D Punch Module (for BP-FN13/FN14)

MX-PN16B/C/D Punch Module (for BP-FN15/FN16)

MX-PF10/PF10L Barcode Font Kit

BP-FX11 Fax Expansion Kit

MX-FWX1/FWX1L Internet Fax Expansion Kit

BP-DD10 Double Feed Detection Kit

MX-AMX1/AMX1L Application Integration Module

BP-AM10/AM10L*** Application Communication Module

BP-AM11/AM11L*** External Account Module

BP-EB10*** Wireless Connection Adaptor

BP-SD10 High Capacity SSD

BP-FR12U/FR12UL Data Security Kit

BP-VD10/VD10L Virus Detection Kit

* Minimum required equipment.
 ** Requires BP-DE12/DE13/DE14/DE15.
 *** In some countries/regions, certain features/functions are standard-equipped (not optional) on the base unit.
 **** BP-FN12 for BP-70M65 and BP-FN11 for the other models.

Certain optional equipment may not be available in some areas.

BP-50M55/50M45 BP-50M55T/50M45T



Copy	Print	Scan	Fax
55/45 PPM	6300 sheets	A3W	55-300 gsm
10.1"	Motion Sensor	5 GB	128 GB SSD
Print 600 dpi	Adobe PS	RSPF 100 sheets	80 OPM
		WiFi	NFC



SMART

Easy Scanning	Multicrop / Image Crop	Card Shot (Multi)	Business Card Feeder
OCR	Business Card Management	USB Direct Scan	USB Direct Print
Network Print	Office Direct Print	ID Card Copy*	Eco Packaging
Saddle Stitch Finisher	Folding Unit	Stapleless Stapler / Manual Stapler	Continuous Run

SECURE

BIOS Firmware Security	Virus Detection	Remote Firmware Updates	AD Group Policy Device Management
Mandatory Access Control	Image Job Log	Server Authentication	S/MIME
Data Encryption / Automatic Erasure	SSL/TLS	Trusted Platform Module	Document Control

CONNECTED

Cloud Storage Connection	Teams Connector	Cloud Mail Connection	Mobile Print
Sharpdesk Mobile	Print Release	Remote Operation	Sharp OSA

■ Functions available ■ Functions available as option □ Functions not available
For explanations of the features, see pages 3 to 8. For details, see the product brochure.

*Similar results can be obtained using another standard built-in function.

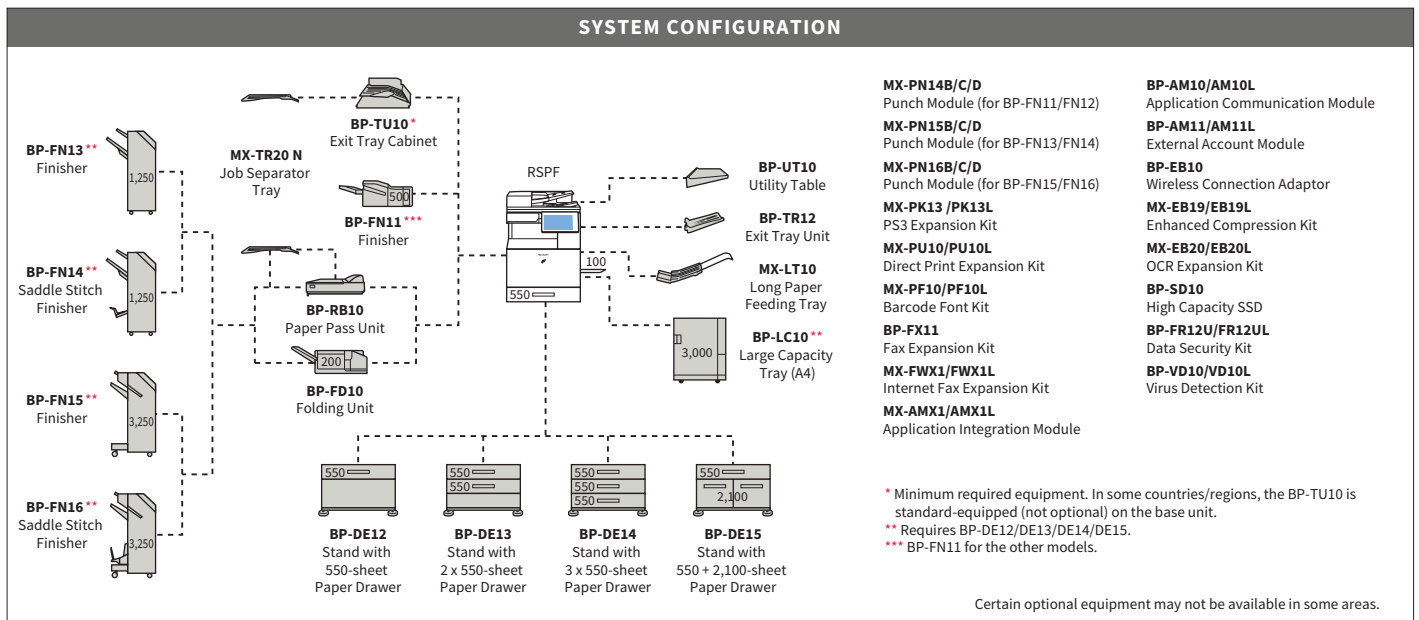

* Minimum required equipment. In some countries/regions, the BP-TU10 is standard-equipped (not optional) on the base unit.
** Requires BP-DE12/DE13/DE14/DE15.
*** BP-FN11 for the other models.

Certain optional equipment may not be available in some areas.

BP-30M35/30M31/30M28 BP-30M35T/30M28T



Copy	Print	Scan	Fax
35/31/28 PPM	2,100 sheets	A3	55-200 gsm
Motion Sensor	4 GB	128 GB SSD	RSPF 100 sheets
Adobe PS	Wi-Fi	NFC	60 OPM
			Print 600 dpi*1



SMART

Easy Scanning	Multicrop / Image Crop	Card Shot (Multi)	Business Card Feeder
OCR	Business Card Management	USB Direct Scan	USB Direct Print
Network Print	Office Direct Print	ID Card Copy*2	Eco Packaging
Saddle Stitch Finisher	Folding Unit	Stapless Stapler / Manual Stapler	Continuous Run

SECURE

BIOS Firmware Security	Virus Detection	Remote Firmware Updates	AD Group Policy Device Management
Mandatory Access Control	Image Job Log	Server Authentication	S/MIME
Data Encryption / Automatic Erasure	SSL/TLS	Trusted Platform Module	Document Control

CONNECTED

Cloud Storage Connection	Teams Connector	Cloud Mail Connection	Mobile Print
Sharpdesk Mobile	Print Release	Remote Operation	Sharp OSA

■ Functions available
 ■ Functions available as option
 Functions not available

SYSTEM CONFIGURATION

BP-FN10 Finisher BP-TR10 Job Separator Tray	RSPF 100 500 500	BP-DS13 Low Stand BP-DS12 High Stand BP-DE11 Stand with 2 x 500-sheet Paper Drawer
BP-SD10 High Capacity SSD MX-PU10/PU10L Direct Print Expansion Kit MX-PK13/PK13L PS3 Expansion Kit MX-PF10/PF10L Barcode Font Kit MX-FX15 Fax Expansion Kit	MX-FWX1/FWX1L Internet Fax Expansion Kit MX-AMX1/AMX1L Application Integration Module MX-AMX2/AMX2L Application Communication Module MX-AMX3/AMX3L External Account Module MX-EB19/EB19L Enhanced Compression Kit	MX-EB18* Wireless LAN Adaptor MX-EB20/EB20L OCR Expansion Kit BP-FR11U Data Security Kit

* Requires an additional part for attachment.
Certain optional equipment may not be available in some areas.

*1 Print resolution of these MFPs is 1,200 x 600 dpi.
*2 Similar results can be obtained using another standard built-in function.



BP-20M31/20M28/20M24/20M22
BP-20M24L
BP-20M31T/20M28T/20M24T
BP-20M24LT



Copy	Print	Scan	Fax
31/28/24/22 PPM	BP-20M31 BP-20M28 2100 sheets	BP-20M24 BP-20M22 BP-20M24L 1850 sheets	A3 55-200 gsm
5-line	Motion Sensor	1 GB	RSPF* 100 sheets 37 OPM*
PS	Wi-Fi	NFC	Print 600 dpi



SMART

Easy Scanning	Multicrop / Image Crop	Card Shot (Multi)	Business Card Feeder
OCR	Business Card Management	USB Direct Scan	USB Direct Print
Network Print	Office Direct Print	ID Card Copy	Eco Packaging
Saddle Stitch Finisher	Folding Unit	Stapless Stapler / Manual Stapler	Continuous Run

SECURE

BIOS Firmware Security	Virus Detection	Remote Firmware Updates	AD Group Policy Device Management
Mandatory Access Control	Image Job Log	Server Authentication	S/MIME
Data Encryption / Automatic Erasure	SSL/TLS	Trusted Platform Module	Document Control

CONNECTED

Cloud Storage Connection	Teams Connector	Cloud Mail Connection	Mobile Print*
Sharpdesk Mobile	Print Release	Remote Operation	Sharp OSA

■ Functions available ■ Functions available as option □ Functions not available
 For explanations of the features, see pages 3 to 8. For details, see the product brochure.

*Not available on BP-20M24L.

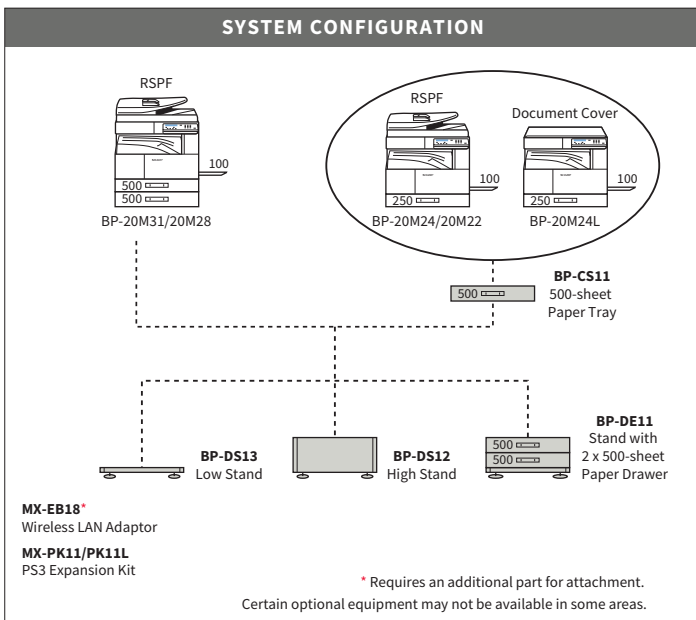

SHARP

- Design and specifications are subject to change without prior notice.
- Microsoft, Active Directory, Excel, Microsoft Teams, OneDrive, PowerPoint, SharePoint, and Windows are trademarks of the Microsoft group of companies. Bitdefender is a trademark or registered trademark of Bitdefender SRL. Google Drive and Gmail are trademarks of Google LLC. Box is a trademark, service mark, or registered trademark of Box, Inc. Dropbox is a trademark or registered trademark of Dropbox, Inc. AirPrint and Mac are trademarks of Apple Inc., registered in the US and other countries. QR Code is a registered trademark of Denso Wave Incorporated in Japan and other countries. Java is a registered trademark of Oracle and/or its affiliates. Adobe and PostScript are either registered trademarks or trademarks of Adobe in the US and/or other countries. PANTONE® and other Pantone trademarks are the property of, and are used under license agreement with, Pantone LLC. Fierly and the Fierly logo are trademarks or registered trademarks of Fierly, LLC. Qualcomm DirectOffice is a product of Qualcomm Technologies, Inc. and/or its subsidiaries. Qualcomm is a trademark of Qualcomm Incorporated, registered in the US and other countries. DirectOffice is a trademark of CSR Imaging US, LP, registered in the US and other countries. All other brand names and product names may be trademarks or registered trademarks of their respective owners.